

SCM Series

FEATURES

-
-
-
-

APPLICATION

-

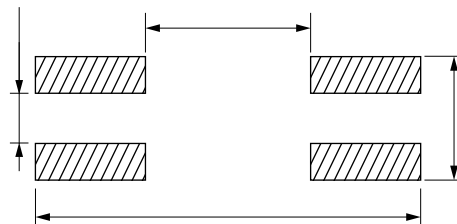
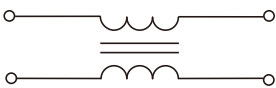
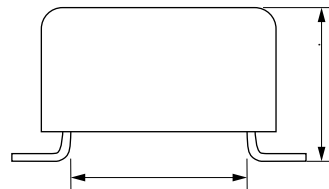
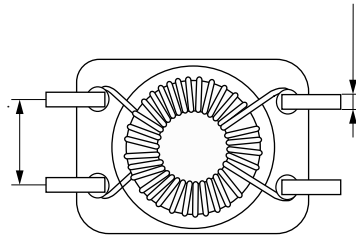
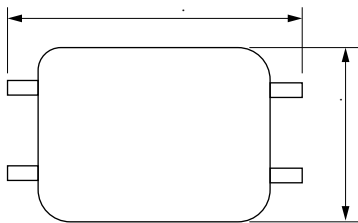
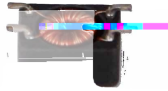

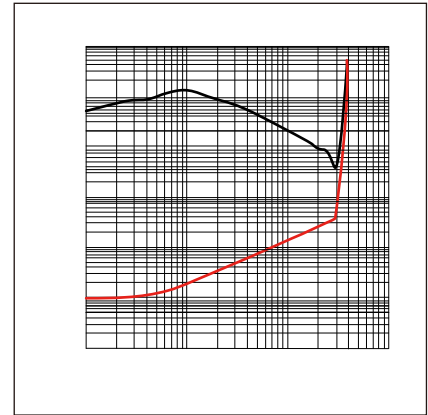
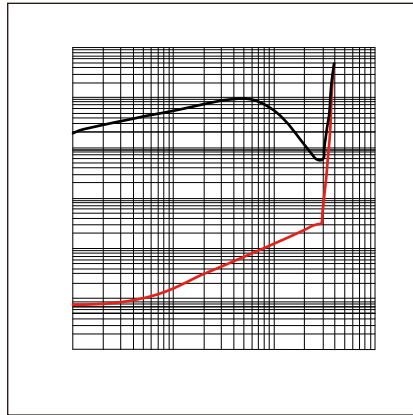
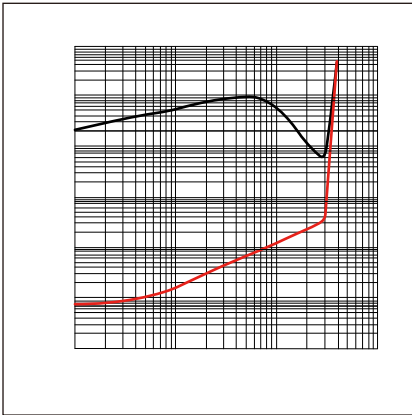

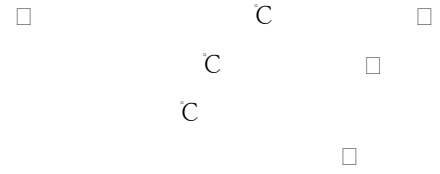
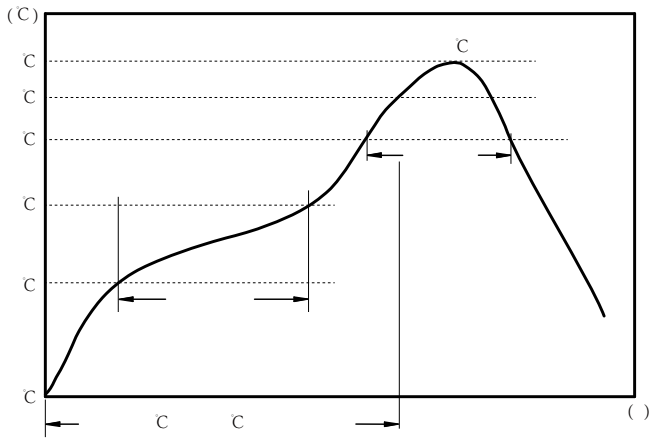

□

:

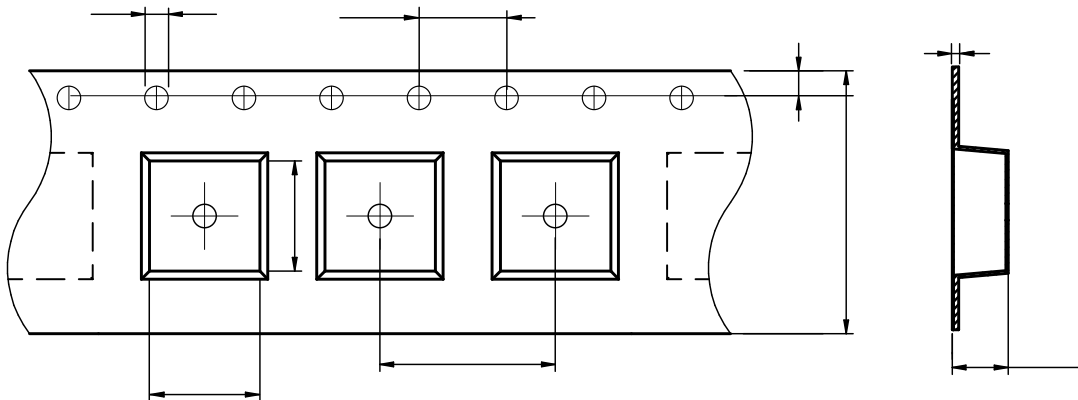

SCM9040	5.85 ± 0.1	9.60 ± 0.1	1.5 ± 0.1	4.0 ± 0.1	8.0 ± 0.1	16.0 ± 0.3	4.92 ± 0.1	1.75 ± 0.1	0.50 ± 0.05

□

Marking	Printing (Inductance)
---------	-----------------------

□ □

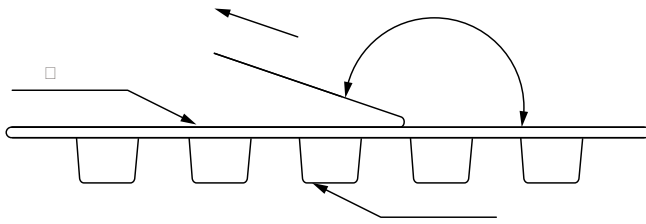

The peel force of top cover tape shall be between 0.1 to 1.17 N

:

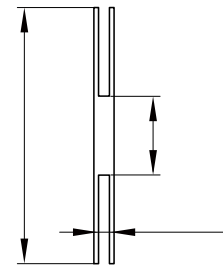
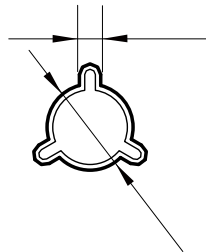

□

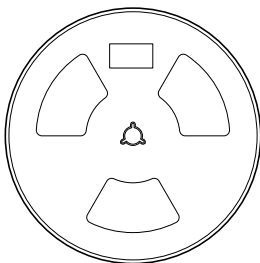

1500 Pcs/Reel

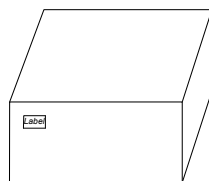

3 Reel /Inner box(4500 Pcs)

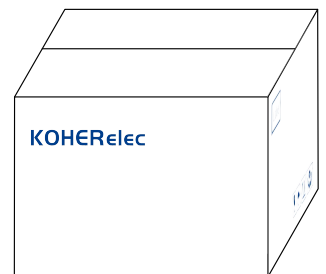

3 Inner box/Carton box(13.5K Pcs)

