

Wire Wound Molded SMD Power Inductors Size 6050



- So saturation
- High current, low DCR, high efficiency
- Very low acoustic noise and very low leakage flux noise
- High reliability
- 100% Lead (Pb)-Free and RoHS compliant
- Operating temperature -55~+125°C (Including self-temperature rise)
- Quantity: 800pcs

- Note PC power system, incl. IMVP-6
- DC/DC converter

Dimensions: [mm]

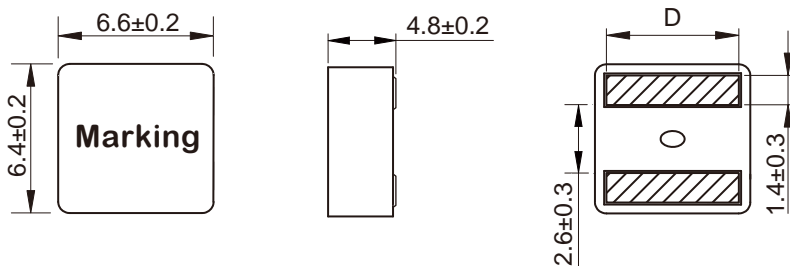

Land Pattern: [mm]

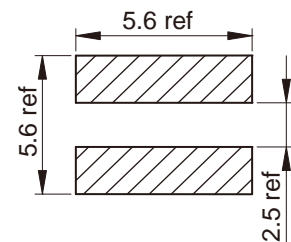

Electrical Properties:

Part No	Inductance @ 100kHz/0.1V (μH)	Tolerance	Saturation Current Typ. (A)	Saturation Current Max. (A)	Temperature Rise Current Typ. (A)	DC Resistance Max. (m Ω)	D (mm)
MDTE6050-R82M	0.82	±20%	24.0	20.0	21.0	4.18	5.3±0.3
MDTE6050-1R0M	1.00	±20%	23.0	18.0	20.0	4.52	5.3±0.3
MDTE6050-1R2M	1.20	±20%	22.0	16.0	18.0	5.83	5.3±0.3
MDTE6050-1R5M	1.50	±20%	19.5	14.5	17.0	6.30	5.3±0.3
MDTE6050-1R8M	1.80	±20%	18.5	13.5	16.0	7.10	5.3±0.3
MDTE6050-2R2M	2.20	±20%	16.0	12.0	13.0	8.50	5.2±0.3
MDTE6050-3R3M	3.30	±20%	12.5	10.0	11.0	12.5	5.2±0.3
MDTE6050-4R3M	4.30	±20%	11.0	8.5	9.0	16.2	5.2±0.3
MDTE6050-4R7M	4.70	±20%	10.5	8.0	8.5	18.4	5.2±0.3

Saturation Current will cause L to drop approximately 30%

Temperature Rise Current: The actual value of DC current when the temperature rise is $\Delta T=40^\circ\text{C}$

Soldering Reflow:

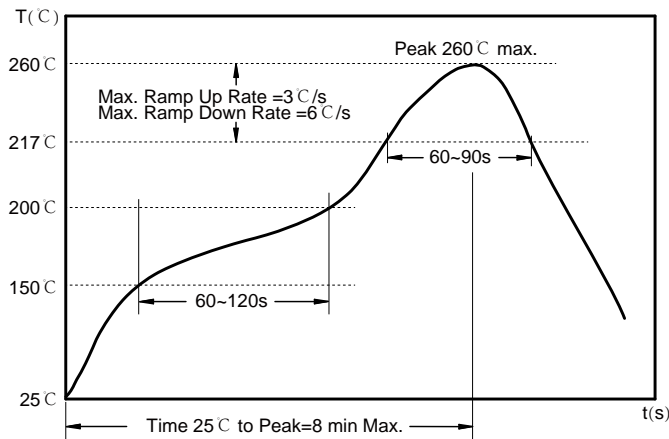

Preheat condition: 150 ~200°C / 60~120 sec.

Allowed time above 217°C: 60~90 sec.

Max temperature: 260°C.

Max time at max temperature: 10 sec.

Allowed Reflow time: 2x max.

Packaging Information:

Tape Dimension:

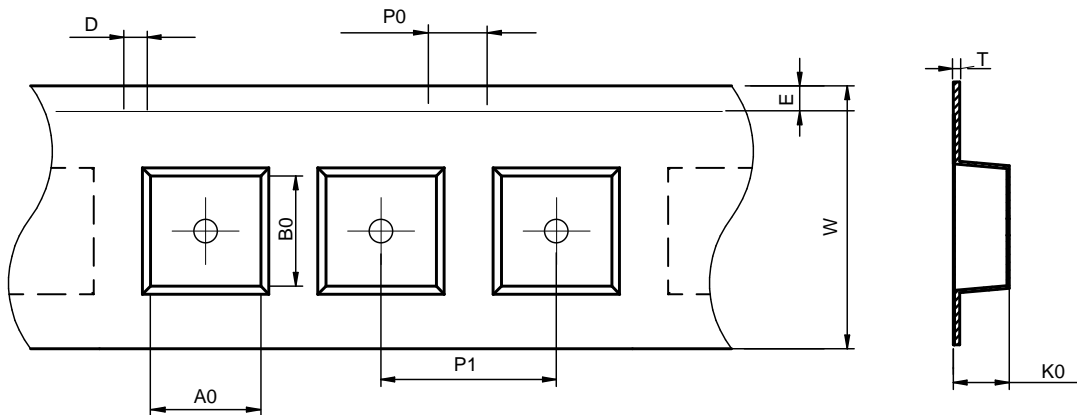

Series	A0 (mm)	B0 (mm)	D (mm)	P0 (mm)	P1 (mm)	W (mm)	K0 (mm)	E (mm)	T (mm)
MDTE6050	7.0±0.1	6.8±0.1	1.5±0.1	4.0±0.1	12.0±0.1	16.0±0.3	5.3±0.1	1.75±0.1	0.35±0.05

Peel force of top cover tape:

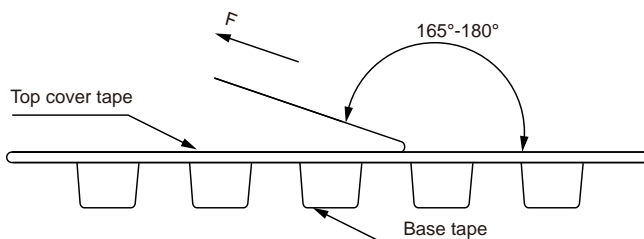

The peel force of top cover tape shall be between 0.1 to 1.3 N

Product Marking:

Marking	Printing (Inductance)
---------	-----------------------

Reel Dimension: [mm]

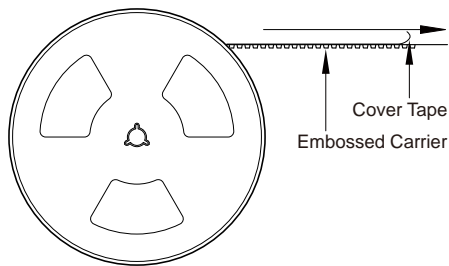

2.2 ± 0.5

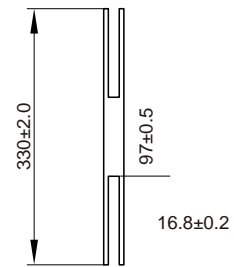

Packaging Quantity:

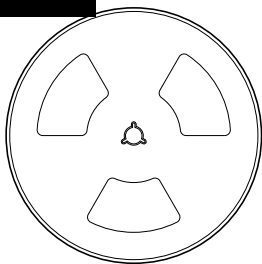

800 Pcs/Reel



2 Reel /Inner box(1600 Pcs)

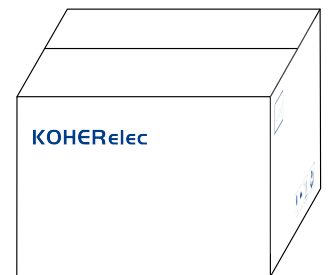

3 Inner box/Carton box(4.8K Pcs)

Cautions and Warnings:

Storage Conditions:

- The storage period is within 10 months after completion of production. Ensure to follow the storage conditions.
-
-
-

Operation Instructions:

-
-
-
-