

MDE Series

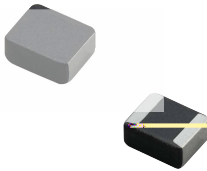

FEATURES

- High saturation current realized by material properties and structure design.
- Low DC resistance to achieve high conversion efficiency and lower temperature rising.
- Low Profile.
- Magnetically shielded structure to accomplish high resolution in EMC protection.
- Halogen free, Lead Free, RoHS Compliance.

APPLICATION

- Generic in portable DC to DC converter line.
- Smart phone, PAD
- DC/DC converter
- Thin-type power supply module.

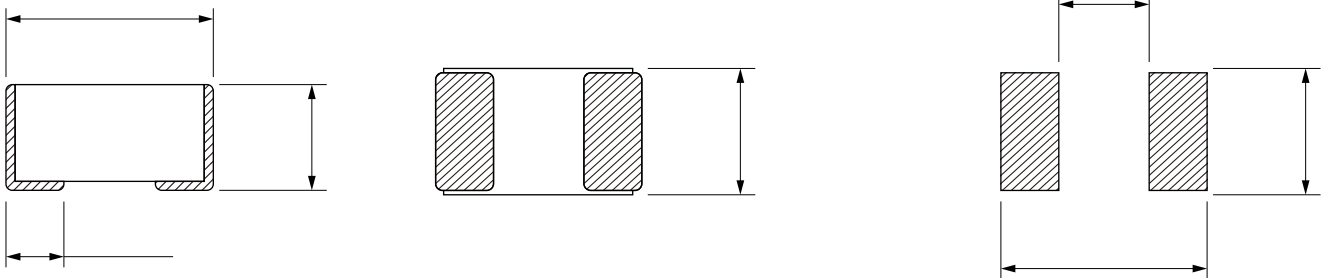

Part No	Inductance @ 1MHz/1V (μH)	Tolerance	DC Resistance Typ. (mΩ)	DC Resistance Max. (mΩ)	Saturation Current Typ. (A)	Saturation Current Max. (A)	Temperature Rise Current Typ. (A)	Temperature Rise Current Max. (A)
MDE252012S-R47M	0.47				6.8	6.2	5.8	4.9
MDE252012S-1R0M	1.0				4.8	4.3	3.9	3.3
MDE252012S-2R2M	2.2			89	3.5	3.2	2.5	2.2

Temperature rising current will cause the coil temperature approximate $T+40^{\circ}\text{C}$
 Saturation current will cause to drop approximately 30%

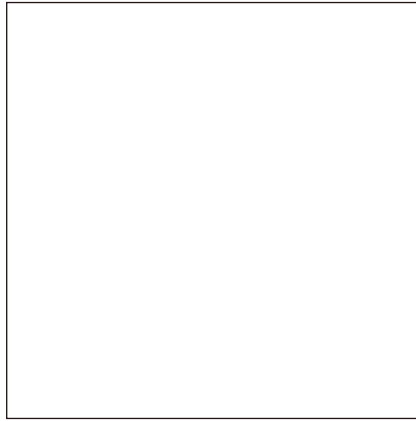
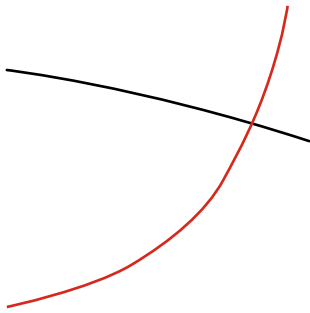

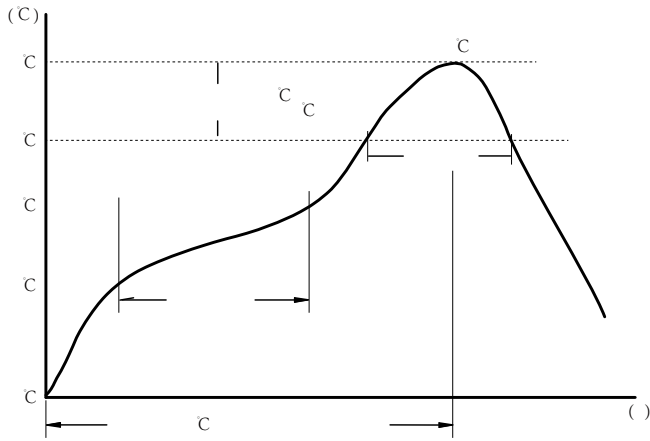

c
c
c

:

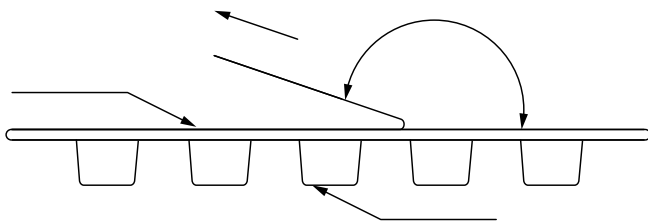

The peel force of top cover tape shall be between 0.1 to 1.3 N

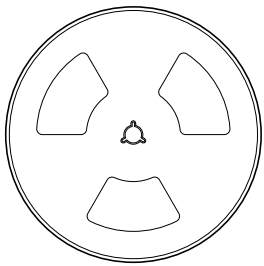
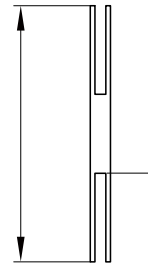
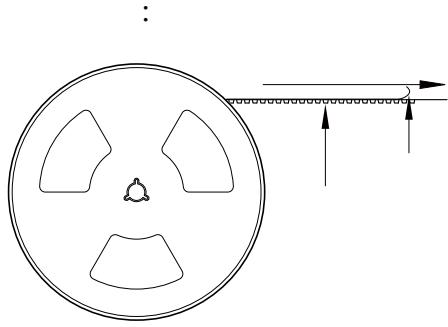

3000 Pcs/Reel

5 Reel /Inner box(15K Pcs)

8 Inner box/Carton box(120K Pcs)

:

•

•

•

•

◁