

# MDE Series

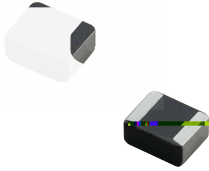

## FEATURES

- 
- 
- 
- 
- 

## APPLICATION

- 
- 
- 
- 

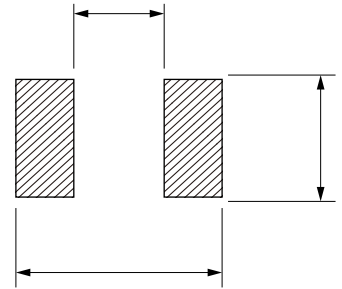
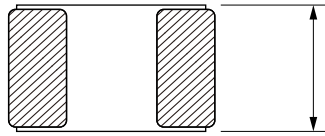
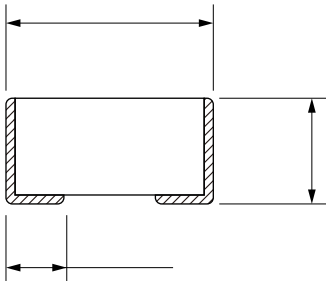



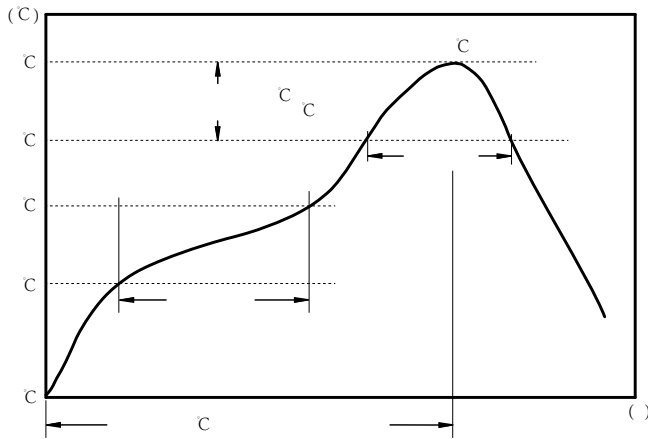

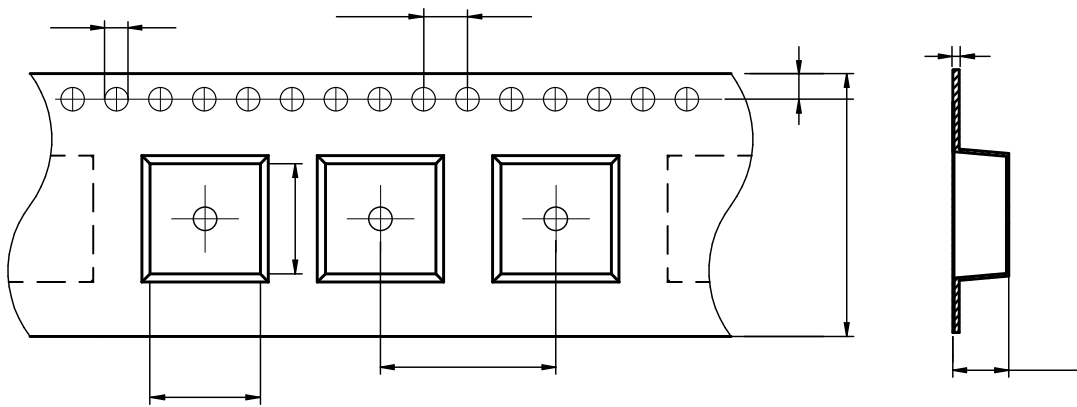

c  
c  
c  
c

:

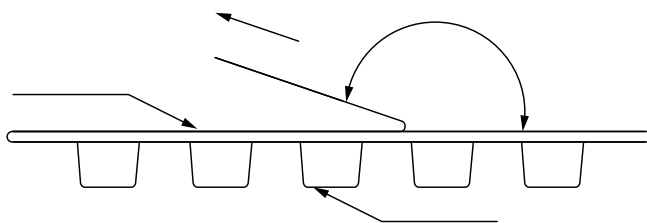

MDE201610S	$1.82 \pm 0.05$	$2.23 \pm 0.05$	$1.55 \pm 0.05$	$4.0 \pm 0.1$	$4.0 \pm 0.1$	$8.0 \pm 0.3$	$1.15 \pm 0.05$	$1.75 \pm 0.1$	$0.22 \pm 0.05$



The peel force of top cover tape shall be between 0.1 to 1.3 N

:

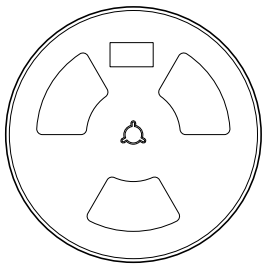
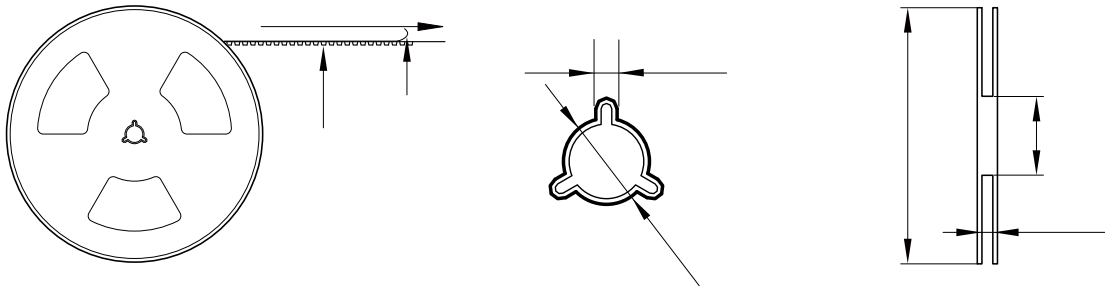

3000 Pcs/Reel

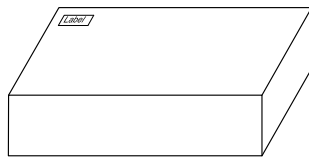

5 Reel /Inner box( 15K Pcs)

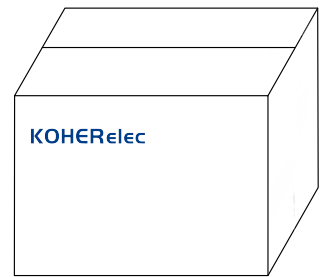

8 Inner box/Carton box(120K Pcs)

:

- 
- 
- 
- 
- 
- 
- 
- 
-