

FBHA Series



FEATURES

-
-

-
-
-
-

APPLICATION

-

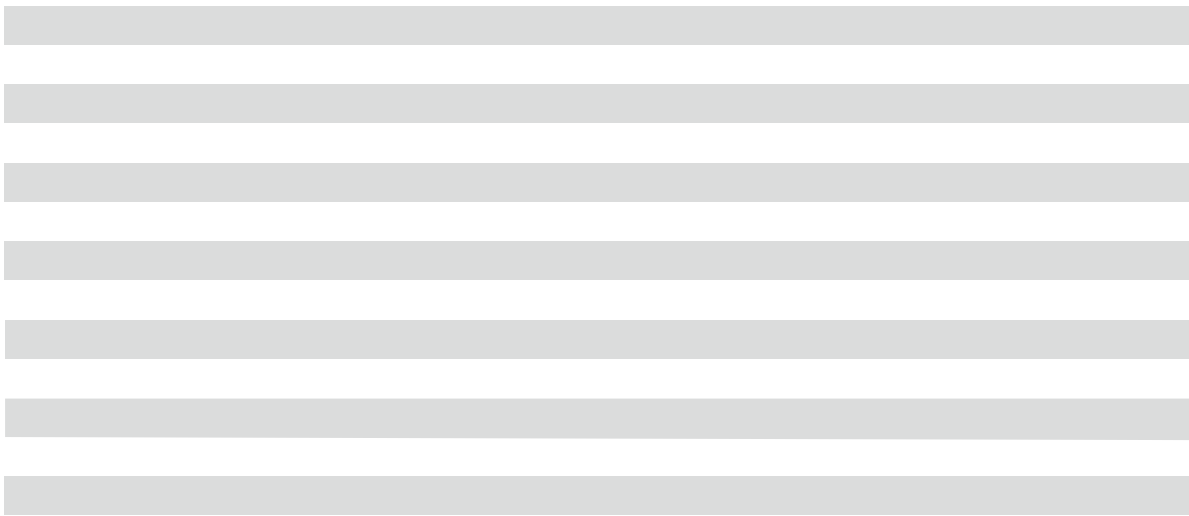

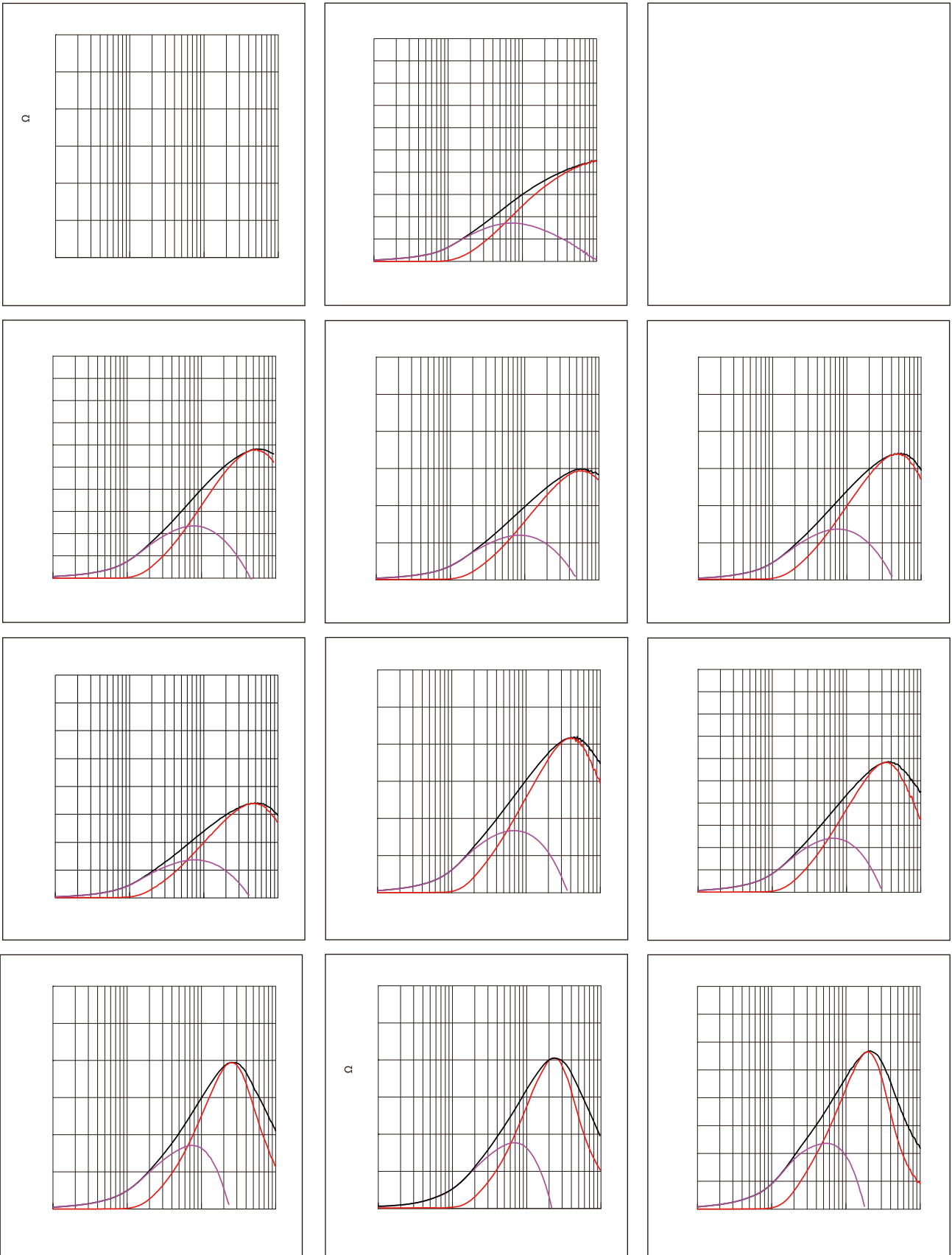

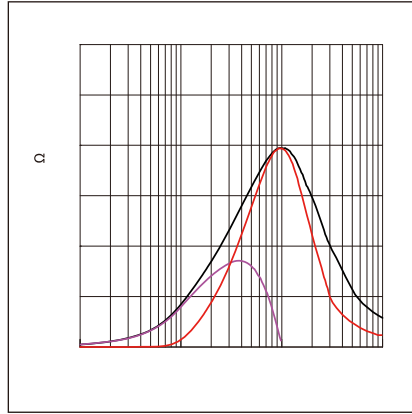
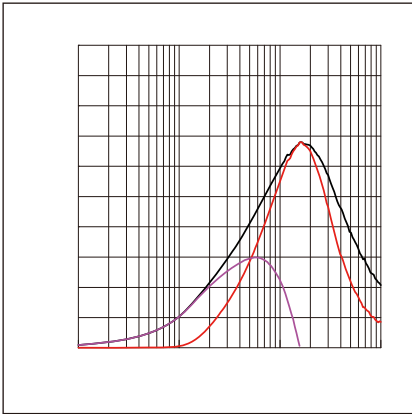

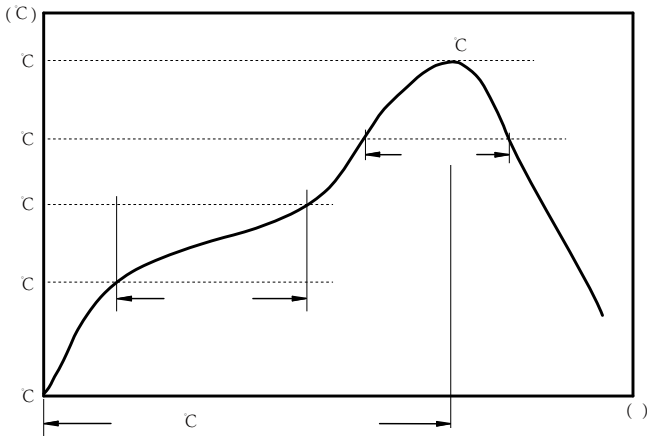

C
C
C

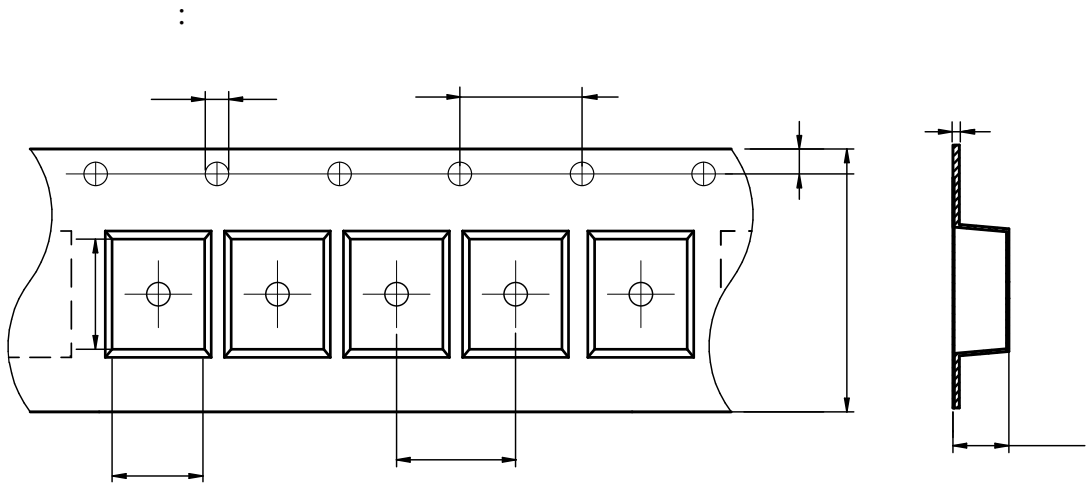

FBHA0603	0.96± 0.05	1.80± 0.05	1.5± 0.1	4.0± 0.1	4.0± 0.1	8.0± 0.3	0.95± 0.05	1.75± 0.1	0.95± 0.05
----------	------------	------------	----------	----------	----------	----------	------------	-----------	------------

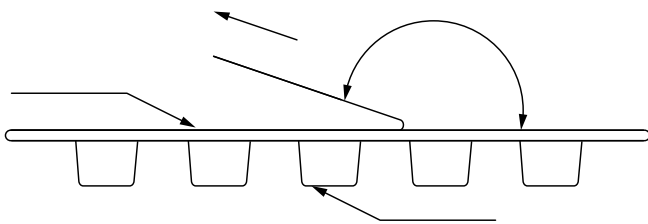

The peel force of top cover tape shall be between 0.14 to 0.58 N

:

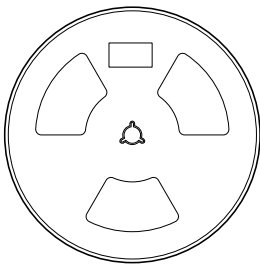
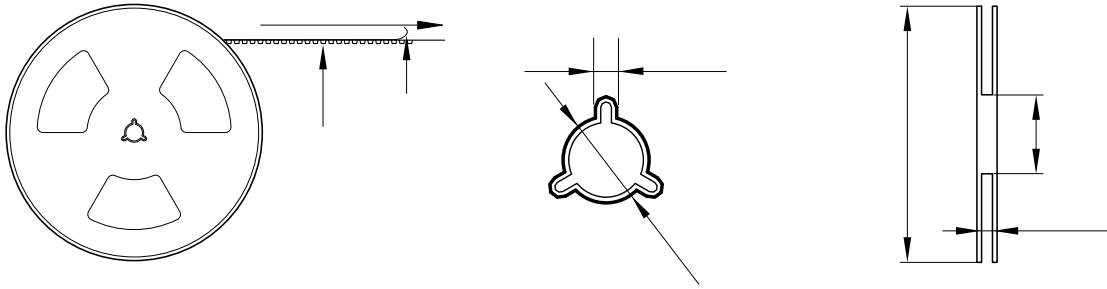

4000 Pcs/Reel

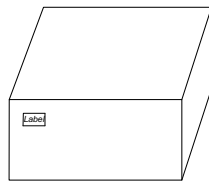

5 Reel /Inner box(20K Pcs)

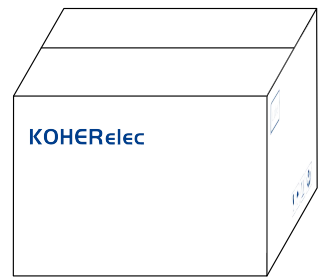

8 Inner box/Carton box(160K Pcs)

:

-
-
-
-
-
-
-
-
-
-